

# Computer Science Transition workbook

- The topic of **Computer Science** is at the heart of the modern world
- Studying it can make you extremely sought after in today's job market
- The transition from GCSE to A level is significant, this includes:
  - An increased emphasis on **technical content**
  - An increased emphasis **independent research**

This workbook is designed to allow you to practice some of these skills and build on your existing knowledge.

**Please complete by your first lesson back in September.**

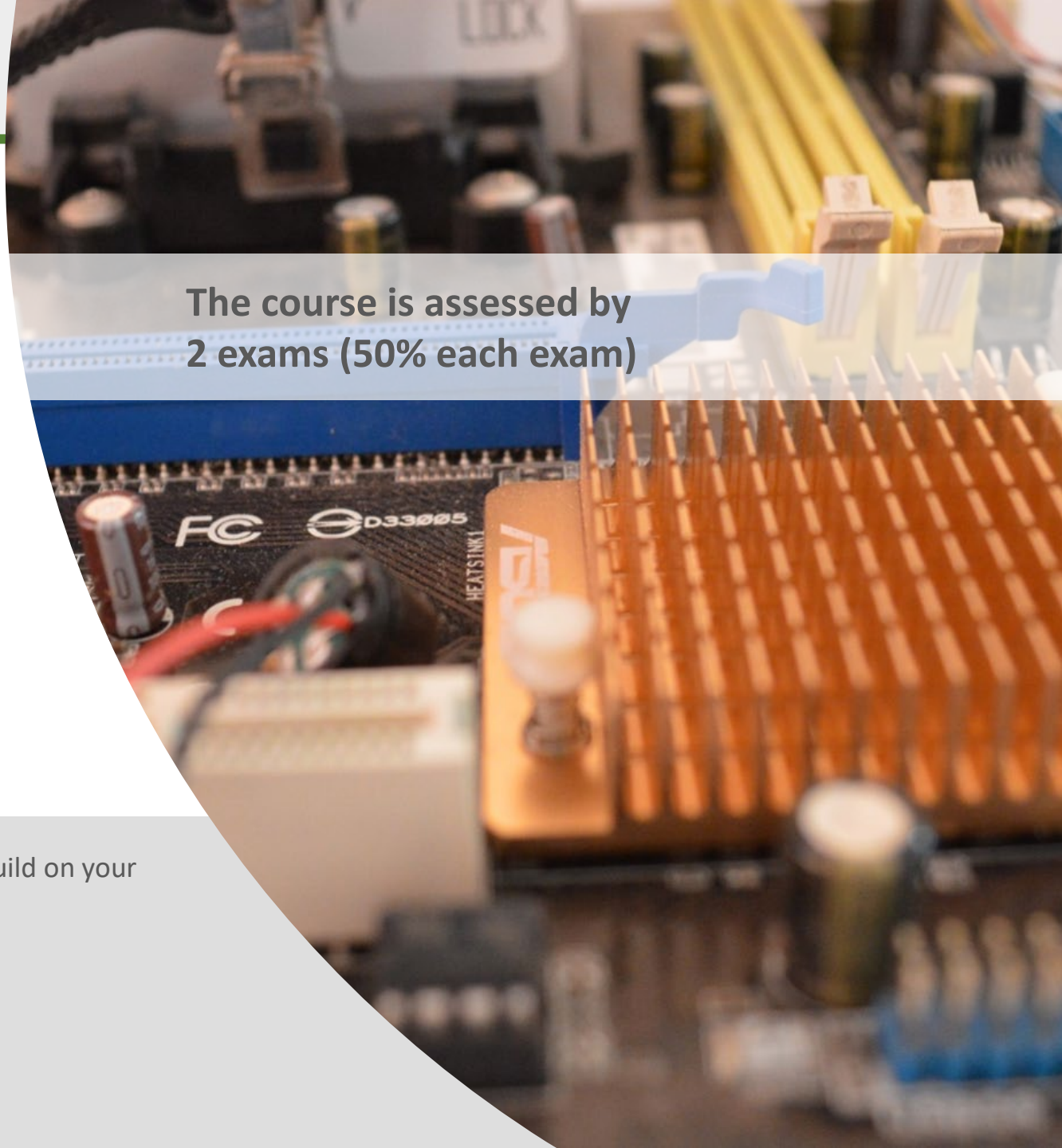

The course is assessed by  
2 exams (50% each exam)

# 1 “Tell me about yourself”



## Why did you choose Computer Science?

Expected time to complete: ½ hour

In this simple task you get the opportunity to tell me your choices and reasons behind choosing to study Computer Science. Please answer all questions as best you can.

1. Why did you choose to study A level Computer Science?

2. What other courses have you chosen to study at Key Stage 5, and what made you choose this combination?

3. What are you hoping to achieve from studying Computer Science?

4. How would you describe yourself as a learner at GCSE? What skills were you good at, what areas would you like to improve on?

5. What are your other hobbies and interests outside of school? Anything related to Computing?

## 2 Independent research task

### Emerging computer technology

Expected time to complete: 2 hours

In this task you get to investigate any area of emerging computer technology which interests you.

You can pick any area which interests you, but examples could be:

- Artificial intelligence
- Robotics
- Automated self driving cars
- Quantum computing

In no more than ONE side of A4 summarise the area you have chosen under the following four headings:

1. What is it?
2. What are the possible Social, Moral, Cultural and Ethical **benefits** of this technology on society
3. What are the possible Social, Moral, Cultural and Ethical **risks** of this technology on society
4. My conclusion on this technology and what it will mean for our world 10 years from now

#### Additional help:

For additional help and support in structuring your answer you might like to watch some of the videos from the following Craig 'n' Dave playlists:

OCR:

SLR 17 – Ethical, morale and cultural issues

<https://student.craigndave.org/videos/slr-17-ethical-moral-and-cultural-issues>

AQA:

SLR 19: Moral, social, legal, cultural issues

<https://student.craigndave.org/videos/slr19-moral-social-legal-cultural-issues>

# 3 What is “computational thinking”?

## Thinking like a computer

Expected time to complete: 2 hours

At the heart of Computer Science is the ability to look at problems, analyse them, break them down and solve them in a way which involves a variety of “Computational Thinking” skills.

- Download the “Computational thinking and Computational methods placemats” from Craig n Dave:
  - <https://student.craigndave.org/specification-key-terminology-and-cheat-sheets>
- Create your own spider diagram / mind map which shows your clear understanding of the 5 different computational thinking strands
  - Keep it to a single side of A4 / A3
- Your goal is to imagine someone else has to revise from your mind map. Ask yourself:
  - Does it make sense?
  - Is it clear?
  - Does it cover all of the important concepts?

**Note:**

Although the five strands listed (and the download resources provided for this task) are from the OCR AS / A’Level specification, the concepts of “Computational Thinking” are just as applicable to the AQA course.

Indeed many of the strands listed are explicitly covered in the AQA specification in different locations.

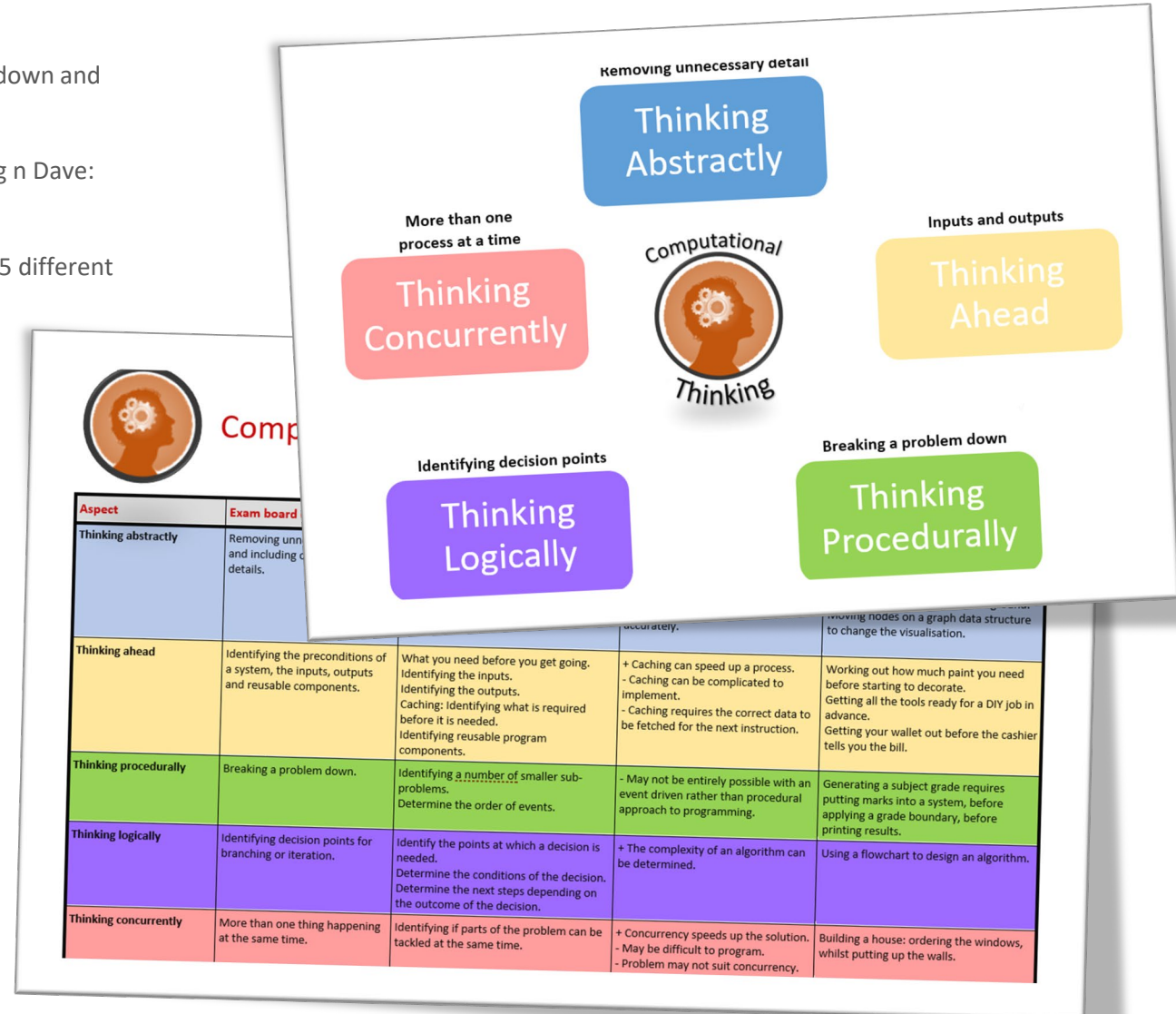

Aspect	Exam board
Thinking abstractly	Removing unnecessary detail and including details.
Thinking ahead	Identifying the preconditions of a system, the inputs, outputs and reusable components. What you need before you get going. Identifying the inputs. Identifying the outputs. Caching: Identifying what is required before it is needed. Identifying reusable program components.
Thinking procedurally	Breaking a problem down. Identifying a number of smaller sub-problems. Determine the order of events.
Thinking logically	Identifying decision points for branching or iteration. Identify the points at which a decision is needed. Determine the conditions of the decision. Determine the next steps depending on the outcome of the decision.
Thinking concurrently	More than one thing happening at the same time. Identifying if parts of the problem can be tackled at the same time.

# 4 Note taking practice task

## The Cornell method of note taking

The expectation to do independent research at A Level will increase dramatically from GCSE.

There is a real skill to taking decent notes outside of lesson which are of value. Research has proven that one of the most effective methods is the “Cornell” note taking method.

- To start download the “Cornell note taking template” from Craig n Dave:
  - <https://craigdave.org/product/cornell-note-taking-template/>
- Pick any two of the following videos from Craig ‘n’ Dave:
  - AQA: <https://student.craigdave.org/videos/aqa-alevel-sl06-procedural-functional-data-abstraction>
  - AQA: <https://student.craigdave.org/videos/aqa-alevel-sl13-sample-resolution-and-rate>
  - AQA: <https://student.craigdave.org/videos/aqa-alevel-sl13-encryption-vernarn-cipher>
  - AQA: <https://student.craigdave.org/videos/aqa-alevel-sl20-bit-rate-baud-rate-bandwidth-and-latency>
  - OCR: <https://student.craigdave.org/videos/ocr-alevel-sl01-alu-cu-registers-and-buses>
  - OCR: <https://student.craigdave.org/videos/ocr-alevel-sl04-paging-segmentation-and-virtual-memory>
  - OCR: <https://student.craigdave.org/videos/ocr-alevel-sl05-stages-of-compilation>
  - OCR: <https://student.craigdave.org/videos/ocr-alevel-sl14-data-structures-part-2-graphs>
- Write the title of the video and its topic in the top boxes (use a different sheet for each video).
- In the main “Notes” section, write notes from the video. You can do this in any way you like, a suggestion might be to rewind slightly when the canvas changes, thinking carefully about what was important in the previous few minutes.
- Having recorded the notes, review them:
  - Turn each part into a question in the section on the left.
  - For example, the notes may say, “The value of the program counter is passed to the memory address register”.
  - The question then becomes, “which register is the value of the program counter passed to?”
  - Sometimes these questions are easy, and at times they are more difficult to write.
  - There may also be more than one valid question.
  - You will need to decide for yourself which are the most appropriate questions for revision.
- Finally pull out all the key words and their definitions words the notes and list them in the bottom section.

Expected time to complete: 1½ hours

Video Title:		Topic/SLR:
Questions	Notes	
Keywords & Definitions		





## Getting to grips with terminology

An important aspect of being successful with your study of Computer Science is getting to grips with subject related terminology. There are over 240 specific terms you will need to learn!

Below are a handful of the key terms you will need to become familiar with.

<b>Control Unit</b>	<b>Register</b>	<b>Busses</b>
<b>Von Neuman Architecture</b>	<b>Optical Storage</b>	<b>Operating System</b>
<b>Intermediate Code</b>	<b>Device Driver</b>	<b>Compiler</b>
<b>Assembly Language</b>	<b>Machine Code</b>	<b>Lossy Compression</b>
<b>Hashing</b>	<b>Normalisation</b>	<b>TCP/IP Stack</b>
<b>Packet Switching</b>	<b>ASCII</b>	<b>Problem Decomposition</b>

1. Research each of the key terms and write a definition.
2. Resist the urge to simply cut and paste a definition from the first website you find. Many definitions found on The Internet are overly complicated and wordy.
3. Ask yourself:
  - Does my definition make sense?
  - Is it succinct, to the point?
  - Does the definition have appropriate depth and detail for A'Level?
  - Could I give this definition to another student so they could revise from it?

Expected time to complete: 2 hours





## Programming basics

Expected time to complete: 6 hours

Learning to “code” is a fun and essential part of A Level Computer Science. This task is ideal if you haven't done the GCSE in Computer Science or you simply want a nice refresher ahead of starting your A Level course.

1. Head over to the web site: <https://www.learnpython.org/>
2. Complete the following python tutorials under the heading:
  - Hello, World!
  - Variables and Types
  - Lists
  - Basic Operators
  - String Formatting
  - Basic String Operations
  - Conditions
  - Loops
  - Functions
3. Each section presents you with theory, code to run and exercises to try out.
4. If you want to practice writing your own python programs you can download and install a simple python development tool here: <https://www.python.org/downloads/>

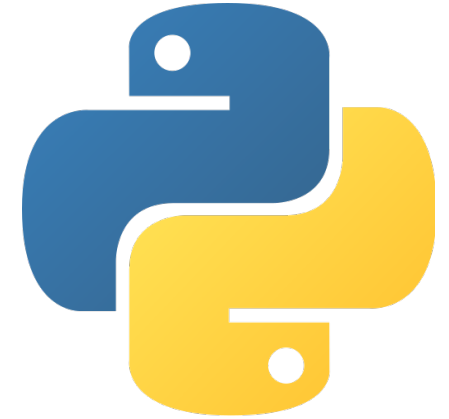

### Additional note:

This task is most suited to students who intend to do the A Level and have not previously gained much / or any programming experience from the GCSE Computer Science course.

Although the language chosen here is Python, and that may not be what you will be using at A Level, it is the underlying programming concepts which are important.

The list of topics above cover the standard set of programming concepts you would be expected to know having completed a GCSE and Computer Science and so will prepare you well for the A level.



## Why is Computer Science important?

Expected time to complete: 2 hours

It is easy to say, “Computer Science is essential in today’s world”, but are you able to think critically about this statement and back it up? “Thinking Critically” is an essential skill at A Level.

It involves you:

- Looking at a topic / concept in depth
- Taking account of different views / perspectives
- Considering positives and negatives
- Evaluating links and effects on other concepts
- Drawing your own conclusions backed up with evidence

1. On the following slide answer the questions:

- What is Computer Science?
- What are the benefits and risks of Computer Science at a local level (think about your local community / town / city / county)
- What are the benefits and risks of Computer Science at a national level
- What are the benefits and risks of Computer Science at a global level

### Additional help:

For additional help and support in structuring your answer you might like to watch some of the videos from the following Craig ‘n’ Dave playlists:

OCR:

SLR 17 – Ethical, morale and cultural issues

<https://student.craigndave.org/videos/slr-17-ethical-moral-and-cultural-issues>

AQA:

SLR 19: Moral, social, legal, cultural issues

<https://student.craigndave.org/videos/slr19-moral-social-legal-cultural-issues>





## Why is Computer Science important?

Expected time to complete: 2 hours

What is Computer Science?

- Enter your answer here

What are the benefits and risks of Computer Science at a local level

- Enter your answer here
- Try to make at least 4 valid points
- At least 2 of your points should be about the potential risks of Computer Science
- At least 2 of your points should be about the potential benefits of Computer Science

What are the benefits and risks of Computer Science at a national level

- Enter your answer here
- Try to make at least 4 valid points
- At least 2 of your points should be about the potential risks of Computer Science
- At least 2 of your points should be about the potential benefits of Computer Science

What are the benefits and risks of Computer Science at a global level

- Enter your answer here
- Try to make at least 4 valid points
- At least 2 of your points should be about the potential risks of Computer Science
- At least 2 of your points should be about the potential benefits of Computer Science

## Augmented reality

Expected time to complete: 1½ hours

A key skill at A Level is being able to take a topic and then discuss it in the context of different scenarios.

Most theory-based exam questions will be asked in the form of a scenario, simply regurgitating what you know on the topic without contextualising your answer to the scenario will often result in low marks!

The topic for this exercise is “Augmented Reality”. It is a truly fascinating area of technology which has the potential to change almost every aspect of our daily lives.

Watch this brief video to learn more:  
<https://www.youtube.com/watch?v=vQtwWzfzKXI>

After watching the video complete the next slide which asks you to discuss the benefits, limitations and risks of augmented reality in the context of:

- Medicine & health care
- Gaming & entertainment
- Schools & learning
- Travel & tourism
- Social media
- Transport & navigation

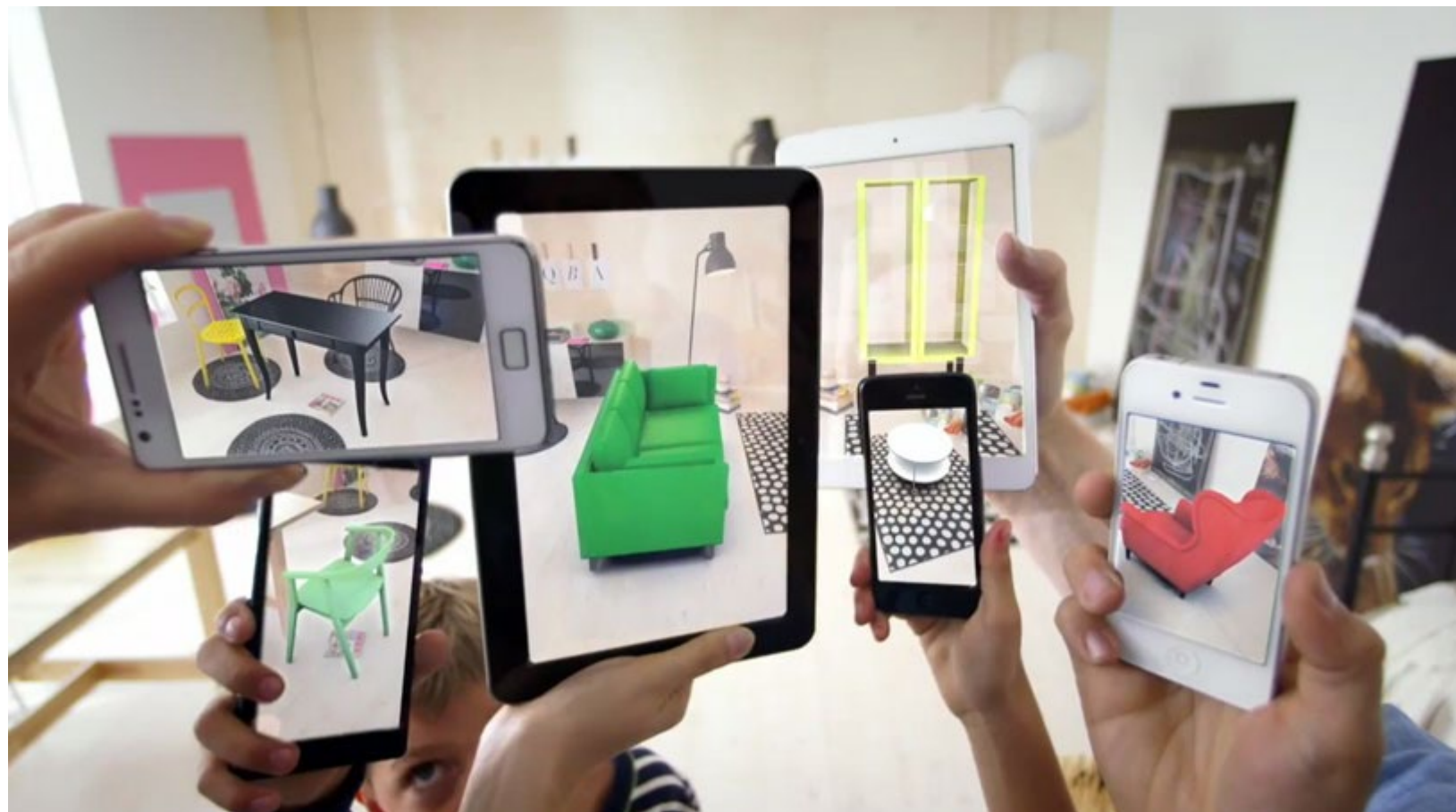

Image by Oyundari Zorigbaatar (20 March 2016) <https://creativecommons.org/licenses/by-sa/4.0/legalcode>



## Augmented reality

Expected time to complete: 1½ hours

### Medicine & health care

Discuss the **benefits, limitations** and **risks** of augmented reality in this context:

- Enter your answer here

### Gaming & entertainment

Discuss the **benefits, limitations** and **risks** of augmented reality in this context:

- Enter your answer here

### Schools & learning

Discuss the **benefits, limitations** and **risks** of augmented reality in this context:

- Enter your answer here

### Travel & tourism

Discuss the **benefits, limitations** and **risks** of augmented reality in this context:

- Enter your answer here

### Social media

Discuss the **benefits, limitations** and **risks** of augmented reality in this context:

- Enter your answer here

### Transport & navigation

Discuss the **benefits, limitations** and **risks** of augmented reality in this context:

- Enter your answer here

## Looking under the hood of the processor

Expected time to complete: 2 hours

The CPU “Central Processing Unit” is the central core of any computer system. You will study what it contains and how it works it in depth at A Level.

1. Start by watching the following 3 videos from Craig ‘n’ Dave (choose from OCR or AQA exam board)
  1. **OCR:** <https://student.craigndave.org/videos/ocr-alevel-sl17-alu-cu-registers-and-buses>
  2. **OCR:** <https://student.craigndave.org/videos/ocr-alevel-sl17-fetch-decode-execute-cycle>
  3. **OCR:** <https://student.craigndave.org/videos/ocr-alevel-sl17-performance-of-the-cpu>
  1. **AQA:** <https://student.craigndave.org/videos/aqa-alevel-sl17-the-processor-and-its-major-components>
  2. **AQA:** <https://student.craigndave.org/videos/aqa-alevel-sl17-alu-cu-registers-and-buses>
  3. **AQA:** <https://student.craigndave.org/videos/aqa-alevel-sl17-performance-of-the-cpu>
2. Produce a fully annotated diagram on a single sheet of A4 / A3 paper which shows how the CPU works.
3. Make sure the diagram includes and covers:
  - Major CPU components and what they are for:
    - Arithmetic Logic Unit (ALU)
    - Control Unit (CU)
    - Cache
  - The main registers
    - Program Counter (PC)
    - Memory Address Register (MAR)
    - Current Instruction Register (CIR)
    - Memory Data/Buffer Register (MDR / MBR)
  - Fetch-decode-execute cycle
  - Include annotations which explain how the performance of a CPU can be improved by:
    - Increasing the clock speed
    - Increasing the cache size
    - Increasing the number of cores

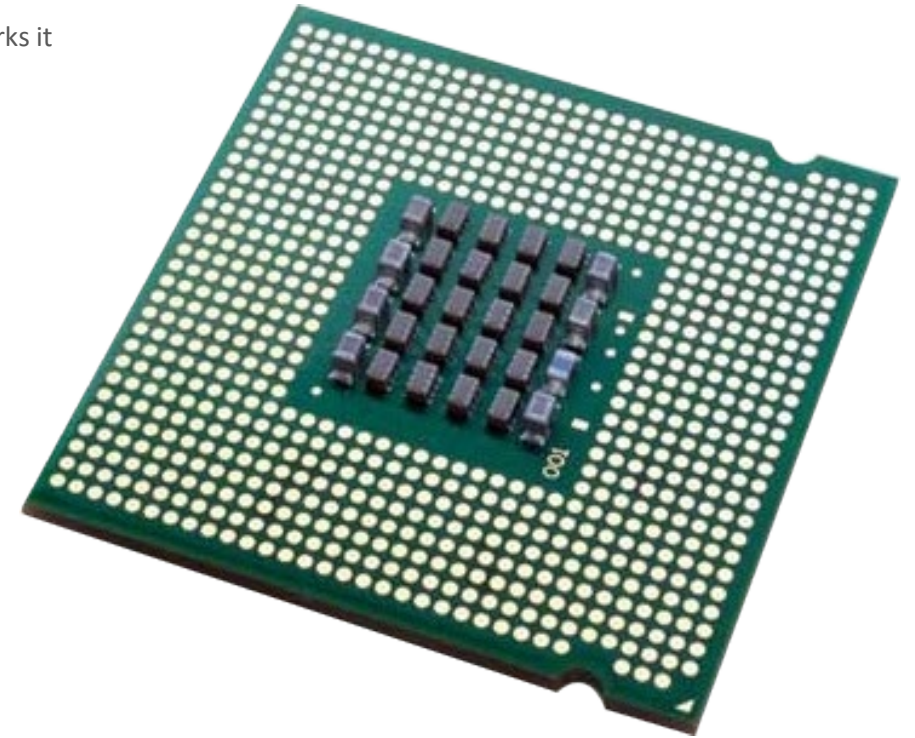



## Different types of memory

Computer memory comes in many different forms, some of the main ones are:

- Random Access Memory (RAM)
- Read Only Memory (ROM)
- Virtual Memory

Carry out some research into these forms of memory and then complete the tasks on the following slide.

Expected time to complete: 1 hour

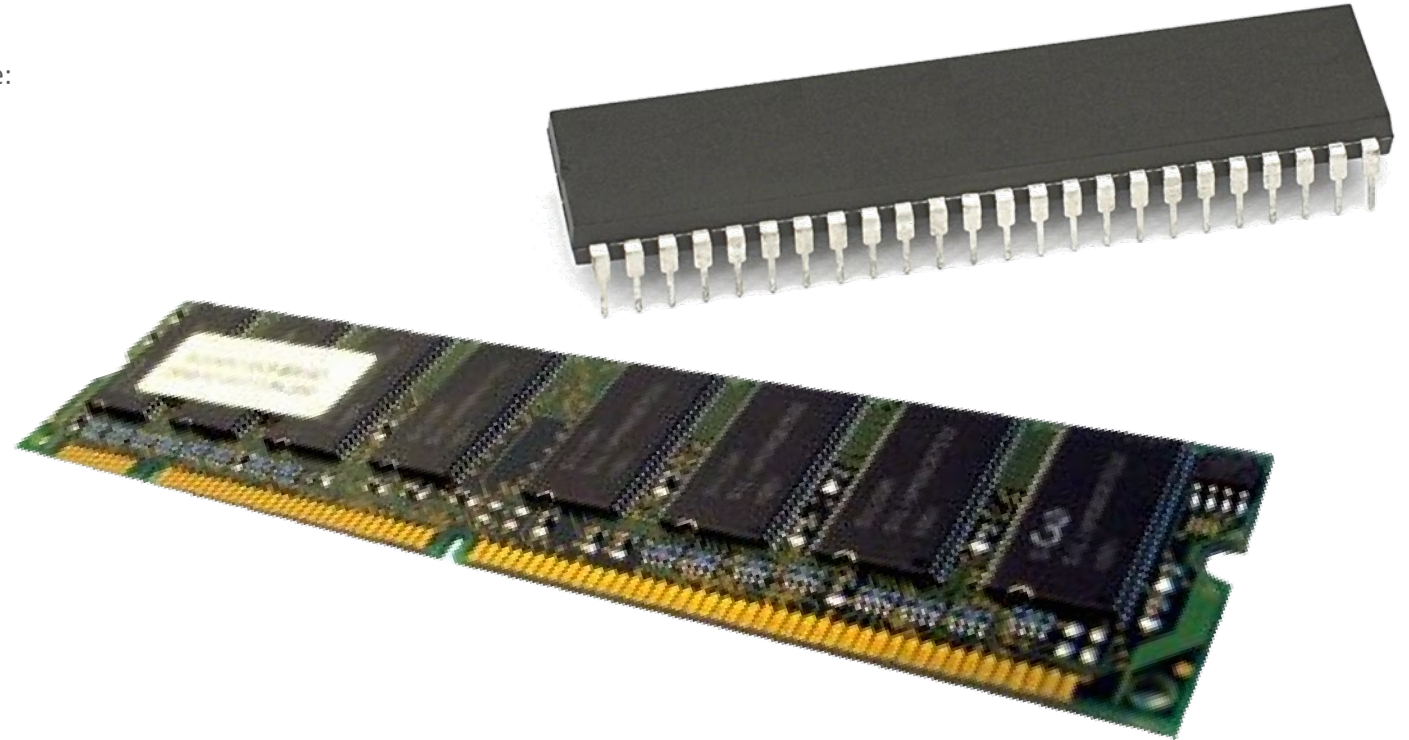

### Additional help:

For additional help and support in completing this task you might like to watch some of the following videos from Craig 'n' Dave:

RAM and ROM:

<https://student.craigndave.org/videos/ocr-gcse-sl1-2-ram-and-rom>

The need for Virtual Memory:

<https://student.craigndave.org/videos/ocr-gcse-sl1-2-the-need-for-virtual-memory>





## Different types of memory



### Random Access Memory (RAM)

- <Enter a definition for RAM>
- <State if RAM is volatile or non volatile>
- <State if RAM is read only or read & writeable>
- <Describe what sort of information RAM typically holds>

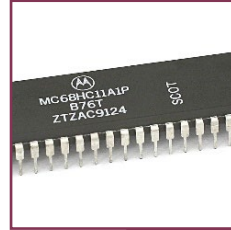

### Read Only Memory (ROM)

- <Enter a definition for ROM>
- <State if ROM is volatile or non volatile>
- <State if ROM is read only or read & writeable>
- <Describe what sort of information ROM typically holds>

Expected time to complete: 1 hour

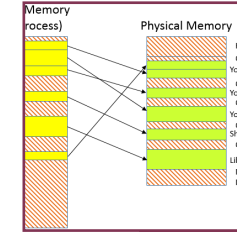

### Virtual Memory

- <Enter a definition for Virtual Memory>
- <Explain why virtual memory is needed>





## Types of secondary storage

Expected time to complete: 1 hour

Virtually all secondary storage devices in use today fit into one of three broad categories:

- Magnetic
- Optical
- Solid state

Carry out some research into these categories and then complete the tasks on the following slide.

### Additional help:

For additional help and support in completing this task you might like to watch some of the following videos from Craig 'n' Dave:

Magnetic, Flash and Optical storage:

<https://student.craigndave.org/videos/ocr-alevel-slr03-magnetic-flash-and-optical-storage>

Comparing capacity and speed of storage media:

<https://student.craigndave.org/videos/aqa-alevel-sl18-comparing-capacity-and-speed-of-storage-media>





## Types of secondary storage

How does it work?

Enter your answer here...

Advantages / Positives

Enter your answer here...

Disadvantages / Negatives

Enter your answer here...

Examples of typical usage

Enter your answer here...

Typical storage capacity range

Enter your answer here...

# Optical Storage



How does it work?

Enter your answer here...

Advantages / Positives

Enter your answer here...

Disadvantages / Negatives

Enter your answer here...

Examples of typical usage

Enter your answer here...

Typical storage capacity range

Enter your answer here...

# Magnetic Storage



Expected time to complete: 1 hour

How does it work?

Enter your answer here...

Advantages / Positives

Enter your answer here...

Disadvantages / Negatives

Enter your answer here...

Examples of typical usage

Enter your answer here...

Typical storage capacity range

Enter your answer here...

# Solid State Storage

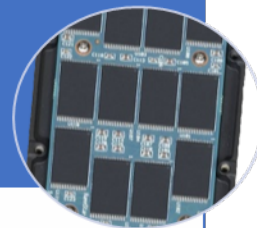



## Types of networks

Carry out some research on computer networks, in particular LANs, WiFi, Network topologies and connectivity devices. Use the symbols on the right (feel free to revise them) to create an appropriate network over the floorplan on the next slide.

Make sure your network meets all the following requirements:

- Each member of the main office needs a desktop PC
- Angela, Pam, Dwight and Oscar also use an office issued smart phone
- The following rooms new access to WiFi:
  - Meeting room (top right)
  - Reception
  - Conference Room
  - Main office
- Use a circle with a transparent fill (so you can see the network underneath) with a width and height of 12.5cm to provide the WiFi coverage needed to cover the rooms above:
  - The circles need to have a WAP at the centre
  - The 12.5cm diameter circles represent the maximum range of each WAP
  - The WAP icons must be attached to a wall
  - You must use the minimum number of WAP possible to provide the coverage needed
- All desktop PCs use wired connections in a star network configuration
  - The top left server room, conference room and main office need to be on one subnet with its own switch
  - All other rooms are on a separate subnet and will require its own hardware for this
  - The two subnets need to be appropriately connected together
- The top left room needs to have a server placed in it and connected appropriately to the local subnet
- The server room needs hardware to appropriately connected the LAN to "The Internet"
- Reception needs a photocopier and it needs connecting to the local subnet
- A firewall should be placed somewhere appropriate

### Additional help:

For additional help and support in structuring your answer you might like to watch some of the videos from the following Craig 'n' Dave playlists:

OCR: SLR 11 – Networks

<https://student.craigndave.org/videos/slr-11-networks>

AQA: SLR21 – Network and the Internet

<https://student.craigndave.org/videos/slr21-networks-the-internet>

Expected time to complete: 2 hours

Use the following symbols:

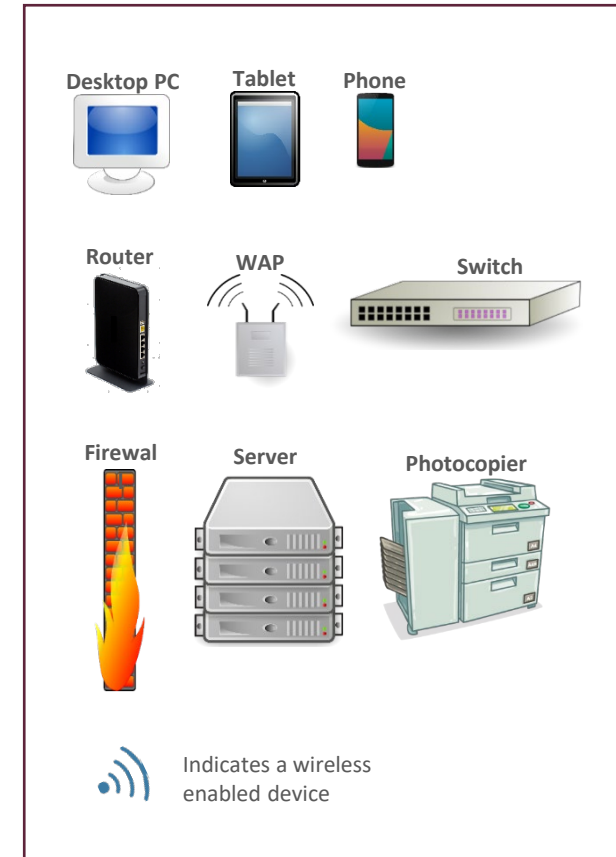



## Types of networks

Expected time to complete: 2 hours

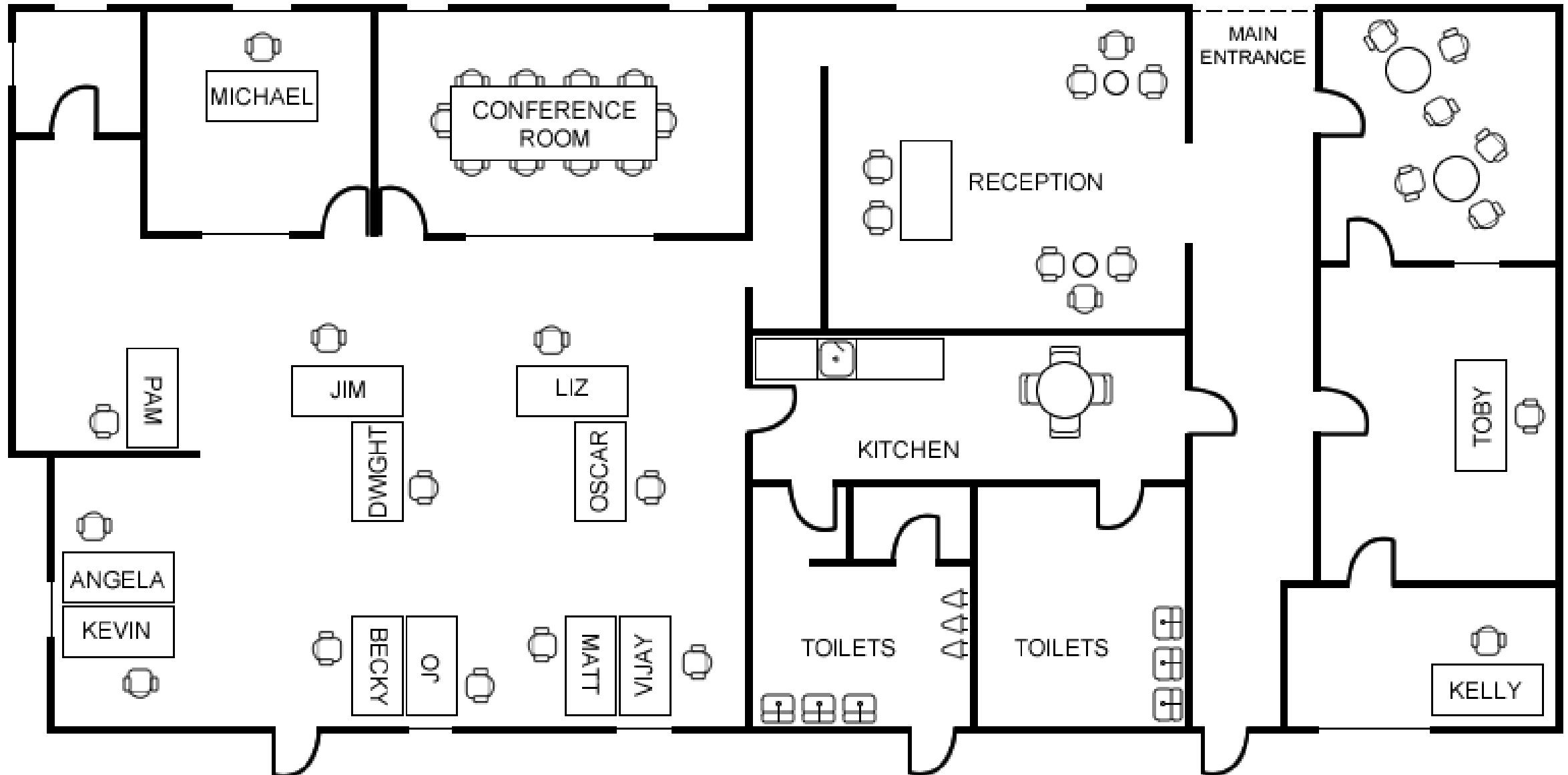



## Operating systems

Operating systems are arguably the most important piece of software installed on a computer.

Carry out some research into the following areas:

- The purpose of operating systems
- The roles of operating systems
- The purpose of interrupts
- How interrupts work as part of the fetch-decode-execute cycle

Complete the tasks on the following slides.

### Additional help:

For additional help and support in structuring your answer you might like to watch some of the videos from the following Craig 'n' Dave playlists:

OCR: SLR 4 – Operating systems – Systems software

<https://student.craigndave.org/videos/slr-4-operating-systems-systems-software>

AQA: SLR14 – Hardware & software

<https://student.craigndave.org/videos/slr14-hardware-software>

Expected time to complete: 2 hours

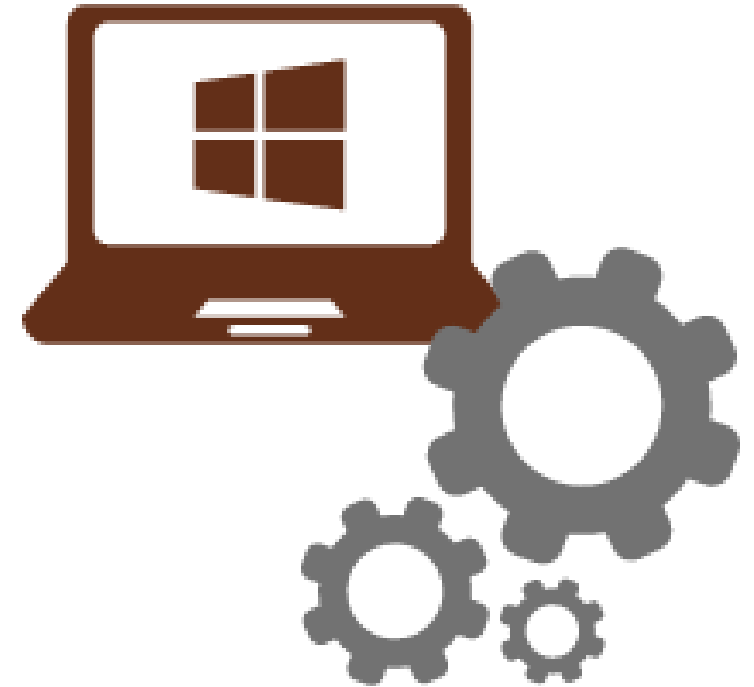



## Operating systems

Expected time to complete: 2 hours

1. List at least 8 different roles an Operating System perform.

# The purpose and roles of an Operating System

<Enter  
answer  
here>

<Enter  
answer  
here>

<Enter  
answer  
here>

<Enter  
answer  
here>

<Enter  
answer  
here>

<Enter  
answer  
here>

<Enter  
answer  
here>

<Enter  
answer  
here>





## Operating systems

Expected time to complete: 2 hours

2. Rearrange the elements in the diagram below to show how the fetch-decode-execute cycle handles interrupts.

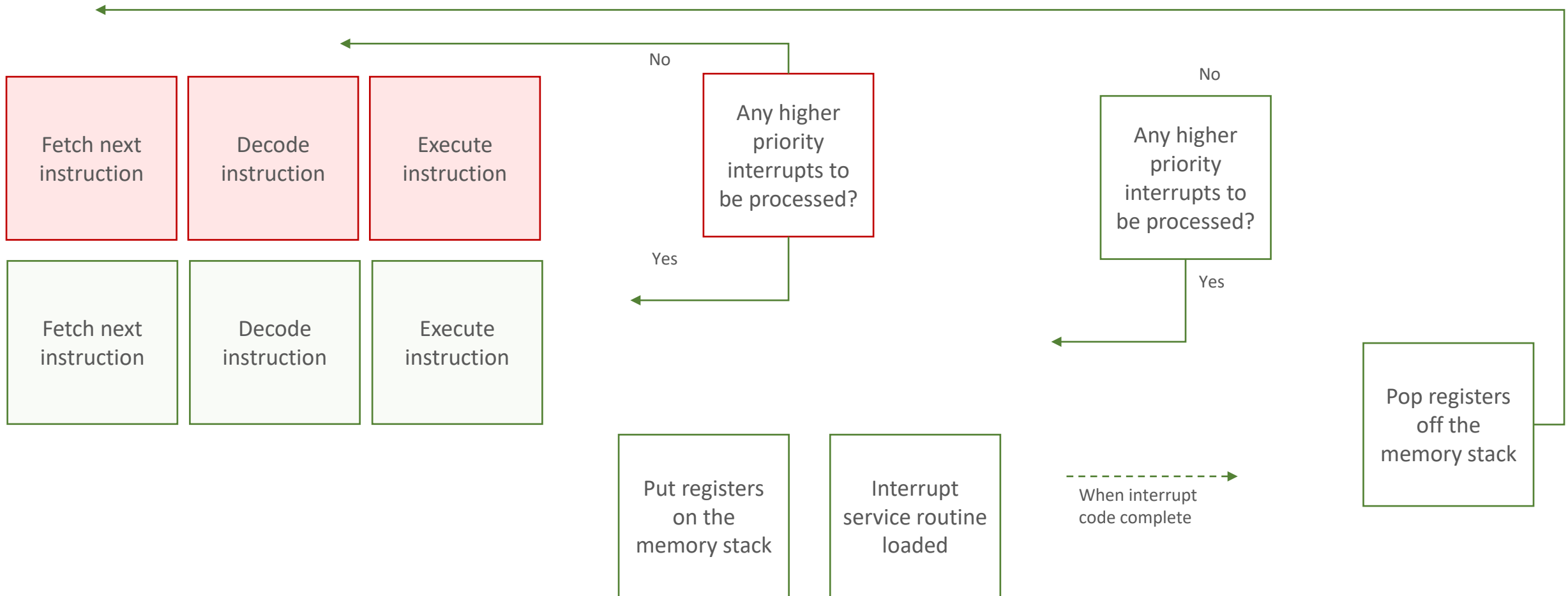



## Operating systems

3. Drag the labels into their correct place on the following diagram:

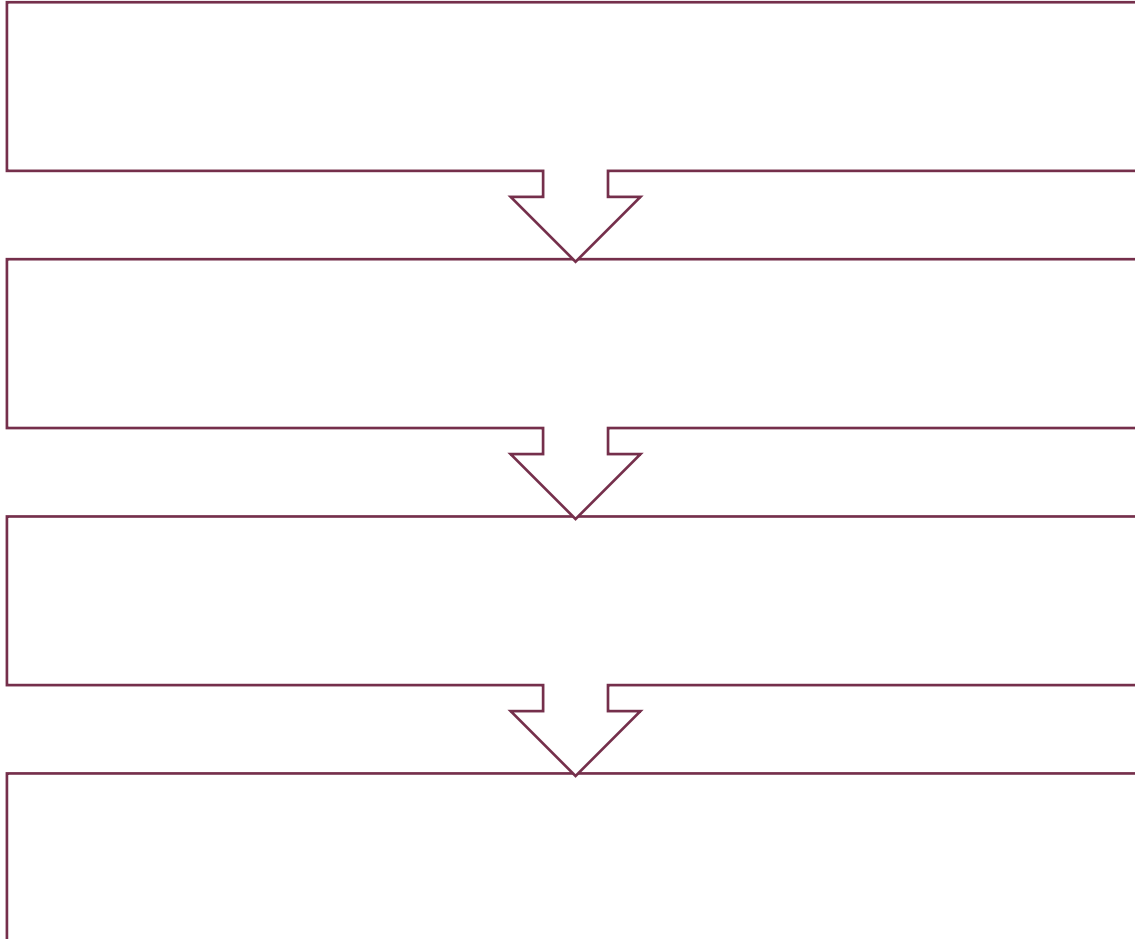

Expected time to complete: 2 hours

4. Explain what this diagram is showing:

Hardware      User  
Applications      Operating System



## Truth tables to circuit diagrams

An important area of computer science is understanding the logic gates and diagrams which are used to represent the physical circuitry of computer systems.

Carry out some research into the following areas:

- Logic gates:
  - AND
  - NAND
  - NOR
  - NOT
  - OR
  - XOR
- Truth tables
- Boolean expressions
- Circuit diagrams

Complete the tasks on the following slides.

### Additional help:

For additional help and support in structuring your answer you might like to watch some of the videos from the following Craig 'n' Dave playlists:

OCR: SLR 15 – Boolean algebra

<https://student.craigndave.org/videos/slr-15-boolean-algebra>

AQA: SLR16 – Logic gates & Boolean algebra

<https://student.craigndave.org/videos/slr16-logic-gates-boolean-algebra>

Expected time to complete: 2 hours

A	B	$A \rightarrow \neg B$
1	1	0
1	0	1
0	1	1
0	0	1

$(P \wedge Q) \leftrightarrow \neg((R \wedge Q) \vee P)$	1	0	1	1
1	0	0	1	1
1	0	0	0	1
0	1	0	0	1
0	1	0	0	1
0	1	0	1	1
0	0	1	0	0
0	0	1	0	0
0	0	0	0	0



## Truth tables to circuit diagrams

Expected time to complete: 2 hours

1. Drag the labels into their correct place on the following diagram:

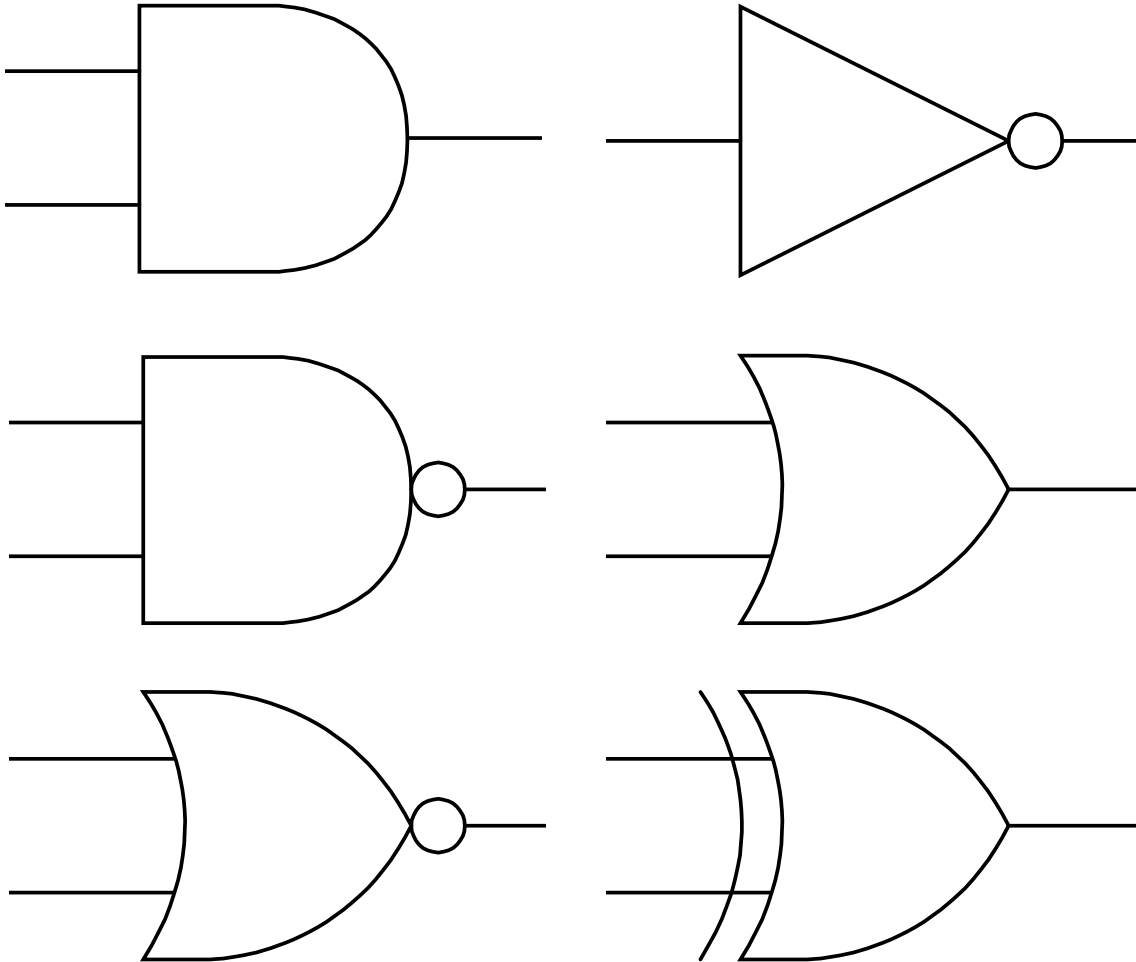

OR

AND

XOR

NOT

NAND

NOR



## Truth tables to circuit diagrams

2. Draw the circuit diagram which would represent the following Boolean expression:

$$\text{AQA Boolean Expression: } F = \overline{(A \oplus B)} \bullet \overline{C}$$

$$\text{OCR Boolean Expression: } F = \neg(\neg C \wedge (A \vee B))$$

A

B

C

F

Expected time to complete: 2 hours

3. Complete the truth table for the circuit diagram you have drawn

A	B	C	D	E	F
0	0	0			
0	0	1			
0	1	0			
0	1	1			
1	0	0			
1	0	1			
1	1	0			
1	1	1			



## Representing negative numbers in binary

Expected time to complete: 1½ hours

In GCSE computer science you will have learnt how to represent positive whole numbers in binary e.g. 47

At A Level you will need to know how to represent negative as well e.g. -47

Start to recapping (or learning if you didn't do the GCSE) how to represent positive whole numbers between 0-255 in binary

Now research how to represent negative numbers in binary using the method known as:

- Two's complement

Complete the tasks on the following slides.

### Additional help:

For additional help and support in structuring your answer you might like to watch some of the following videos from Craig 'n' Dave:

GCSE recap: How to represent positive binary values 0-255  
<https://student.craigndave.org/videos/aqa-gcse-slr13-number-bases>

A Level: Representing negative binary values using Two's Complement  
<https://student.craigndave.org/videos/aqa-alevel-slr11-twos-complement>







## Converting between base-2, base-10 and base-16

Expected time to complete: 1½ hours

As humans we have use the decimal or denary number system (base-10), made up of the unique digits 0-9.

Computer systems at the most basic level use only binary 1's and 0's (base-2).

As a computer scientist you will also need to become familiar with the hexadecimal number system (base-16).

You will also need to be comfortable with converting numbers between these three base systems.

Research the following areas:

- Base-2 binary number system
- Base-10 decimal/denary number system
- Base-16 hexadecimal number system
- How to convert between base-2, base-10 and base-16

Complete the tasks on the following slides.

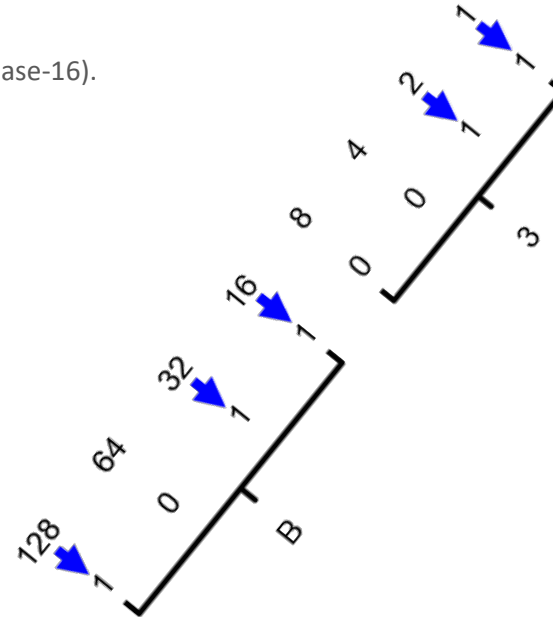

### Additional help:

For additional help and support in structuring your answer you might like to watch some of the following videos from Craig 'n' Dave:

Base 2, 10 and 16 number systems:

<https://student.craigndave.org/videos/aqa-alevel-sl10-base-2-10-and-16-number-systems>

Converting between binary, hex and decimal:

<https://student.craigndave.org/videos/aqa-alevel-sl11-aqa-converting-between-binary-hex-and-decimal>

Denary	Binary	Hexadecimal
0	0000	0
1	0001	1
2	0010	2
3	0011	3
4	0100	4
5	0101	5
6	0110	6
7	0111	7
8	1000	8
9	1001	9
10	1010	A
11	1011	B
12	1100	C
13	1101	D
14	1110	E
15	1111	F



## Algorithms: from theory to practice

Expected time to complete: 4 hours

A core concept of computer science is that of data structures and algorithms.

It is also an area which many students struggle with during examinations.

Probably the most basic algorithm is that of the “linear search”.

If you have done the GCSE course you will have learnt about this searching algorithm already.

Start by learning or refreshing your knowledge of the linear search algorithm by using the videos on this page:

- <https://www.craigndave.org/algorithms-linear-search>

Once you are happy with the theory complete the exercises on the following slides.



## Algorithms: from theory to practice

Expected time to complete: 2 hours

1. Describe what the linear search algorithm does.

2. What are the applications of the linear search algorithm?

3. Write out the steps of the linear search algorithm in simple-structured English.

4. Draw a simple diagram which illustrates the linear search algorithm.



## Algorithms: from theory to practice

Expected time to complete: 2 hours

5. Write out pseudocode for the linear search algorithm.
  - The algorithm should use an array called items which is pre-populated with the following values: "Florida", "Georgia", "Delaware", "Alabama", "California"
  - The algorithm should ask the user to "Enter the state to find:"
  - If the algorithm locates the state entered by the user in the array it should report back to the screen "Item found at position n"
  - If the algorithms can not locate the state entered by the user in the array it should report back to the screen "Item not found"



## Algorithms: from theory to practice

Expected time to complete: 2 hours

6. Have a go at coding the linear searching algorithm in a programming language of your choice.
  - The program should work use an array called items which is pre-populated with the following values: "Florida","Georgia","Delaware","Alabama","California"
  - The program should ask the user to "Enter the state to find:"
  - If the program locates the state entered by the user in the array it should report back to the screen "Item found at position n"
  - If the program can not locate the state entered by the user in the array it should report back to the screen "Item not found"

**Cut and paste the code you have written into the box below:**